

Aspirator with trap flask FTA-1

Operating instructions

For version V.4GW



Contents

1	Safety	3
2	General Information	5
3	Getting started	6
4	Operation	7
5	Specifications	9
6	Guarantee and service	10
7	Declaration of Conformity	11





1. Safety

The following symbols mean:







Caution! Read these operating instructions fully before use and pay particular attention to sections containing this symbol.



GENERAL SAFETY



-  Operation of the unit must be carried out according to the given operating instructions.
-  The unit should not be used if dropped or damaged.
-  After transport or storage in humid conditions dry out the unit (2-3 hrs) before connecting it to the mains.
-  Before using any cleaning or decontamination method except those recommended by the manufacturer, check with the manufacturer that the proposed method will not damage the equipment.
-  Do not attempt to modify the unit.

ELECTRICAL SAFETY



-  Connect only to an external power supply with a voltage corresponding to that on the serial number label.
-  Use only the external power supply unit provided with this product.
-  Ensure that the external power supply and switch is easily accessible during use.
-  Before moving the unit disconnect the external power supply from the mains outlet.
-  If liquid is spilt inside the unit, disconnect it from the external power supply and have it checked by a competent person.

DURING OPERATION

-  Do not operate the unit in premises with aggressive or explosive chemical mixtures.
-  It is not allowed to use aggressive organic compounds, chlorinated solvents, strong conjugated acids for operation with the unit.
-  Do not operate the unit outside the laboratory premises.

-  Do not operate the unit if you think it may have been incorrectly installed or repaired.
-  Do not leave the operating unit unattended.

BIOLOGICAL SAFETY

-  It is the user's responsibility to carry out appropriate decontamination if hazardous material is spilled on or inside the equipment.
-  Do not allow the collected buffer level to exceed the max. level (see Figure 1/5). Empty the trap flask when the liquid level reaches maximum. Take necessary precautions utilizing waste liquid in accordance with general laboratory standards.

2. General Information

Aspirator with trap flask FTA-1 is designed for aspiration (removal) of alcohol (or buffer) remaining quantities from microtest tube walls during DNA (RNA) purification and other macromolecule reprecipitation techniques.

FTA-1 can also be used for routine operations of cells washing from cells culture medium and resuspension in buffer. The aspirator operation principle is based on creating negative pressure in trapping flask by the microcompressor. The trap flask is connected with collecting to the tip by a silicone tube. Liquid is removed from the microtest tube when the tip touches the solution surface. There is a tube holder for 2 tubes conveniently located on the right hand side of the unit, these tubes can hold acid solution and distillate for the collecting tip to be washed and stored for re-use.

A hydrophobic microbiological filter eliminates risk of contamination from the trap flask with bacteria, viruses and infected particles. Hydrophobic microbiological filter efficiency up to 99.9% holds particles bigger than 0.027 micron.

In order to prolong serviceability and efficiency of device it is important not to use aggressive organic compounds such as phenol and strong conjugated acids such as guanidine for aspiration. It can cause damage not under warranty! Please, contact manufacturer to confirm chemical resistance of any chemical compounds.

3. Getting started

3.1. Unpacking

Remove packing materials carefully and retain for future shipment or storage of the unit.

3.2. Complete set

Unit set includes:

Standard set

- Aspirator FTA-1 1 pce.
- Trap flask 1 pce.
- Hydrophobic microbiologic filter 2 pce.
- Aspiration tubes with fittings 1 set
- Aspiration tip 1 pce.
- Storing tube for aspiration tip 1 pce.
- External power supply 1 pce.
- Operating instructions, Declaration of conformity 1 copy

Optional accessories

- 8-channel aspiration manifold MA-8 with holder 1 pce.

3.3. Set up

- place unit on an even working horizontal surface;
- install the trap flask on the unit;
- screw the lid with the filter, inlet and outlet silicone tubes on the trap flask;
- screw the tube coming out from the filter to the socket connector of the pump (Fig.1/1) located on top of the unit (turning clockwise);
- ensure that the filter is tightly inserted in the socket (Fig.1/2);
- place the tube into a holder (fig.1/4) situated at FTA-1 right hand side.
- plug the external power supply into the socket at the rear side of the unit and position the unit so that there is easy access to the external power supply and power switch.

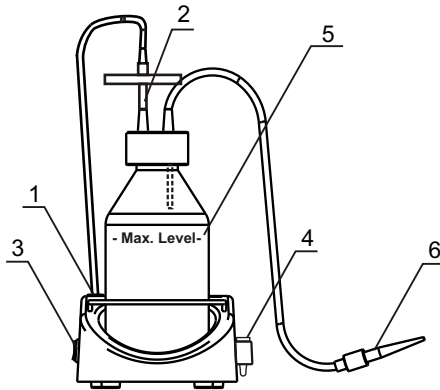

Fig.1 Assembled unit

3.4. Optional aspiration tip MA-8 installation

- remove tubes from the holder situated at FTA-1 right hand side (fig.1/4);
- place MA-8 storing holder (fig.1/1) into the holder (fig.2/↓);
- remove standard aspiration tip from the inlet tube (fig.1/6) and connect the aspiration tip MA-8 (fig.2/2);

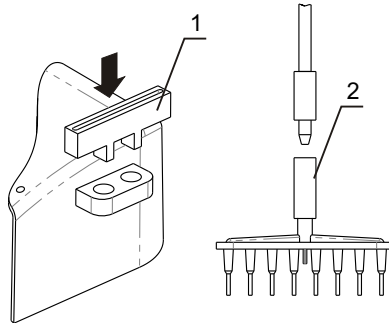



Fig.2 Optional aspiration tip MA-8 installation

4. Operation





- 4.1. Connect external power supply unit to the mains.
 - 4.2. Switch ON the unit with the Power switch on the side surface (fig.1/3).
 - 4.3. To remove liquid from the microtest tube, touch the solution surface with the aspiration tip.
 - 4.4. To wash or store the aspiration tip, use the holder (fig.1/4) situated at FTA-1 right hand side. Holder designed for 2 tubes (e.g. for hydrochloric acid solution and distillate).
-  **Caution!** During operation do not allow the collected buffer level to exceed the max. level (see Figure 1/5). Empty the trap flask when the liquid level reaches maximum (according to p. 4.6).
- 4.5. At the end of operation switch OFF the Power switch (fig. 1/3) and disconnect the external power supply from the mains outlet.
 - 4.6. Take necessary precautions utilising waste liquid in accordance with general laboratory standards.





5. Specifications

The product is designed for operation indoors in a laboratory at altitudes up to 2000m, with ambient temperature from +4°C to +40°C and maximum relative humidity 80% for temperatures up to 31°C decreasing linearly to 50% relative humidity at 40°C.

- Vacuum.....-500 mbar
- Filtration.....hydrophobic microbiologic filter 2200/02
eliminates risk of contamination from the trap flask with bacteria, viruses
and infected particles
- Diameter of filter pores 0.027 micron
- Dimensions160x210x340 mm
- Input current/power consumption.....12V, 0.3A/ 3.6 W
- External power supplyinput AC 100-240 V 50/60Hz, output DC 12V
- Weight with trap flask, not more.....1.7 kg

Optional accessories	Description
 see. fig.3	8-channel aspiration manifold MA-8 with holder

Replacement parts	Description
 1	Outgoing filter tube adapter (90°) with short tube
 2	Hydrophobic microbiologic filter FA-1
 3	Adapter between cap and hidrofobic filter
 4	Small 90° elbow
 5	Trap flask 1L with lid, cup insert and sealer

Replacement parts	Description
6 	UNF male threaded adapter
7 	Aspiration tip 200 mkl
8 	Adapter between tube and aspiration tip
9 	Female luer bulkhead - hose barb adapter
10 	Male luer lock - hose barb adapter
11 see. fig.3	Silicone tube set 6 pcs. (outer x inner diam. x length mm: 8x5x300, 8x5x25, 8x5x16, 5x3x850, 5x3x50, 5x3x15)
12 see. fig.3	Tubing set (all tubes with fittings except filter and aspiration tip)

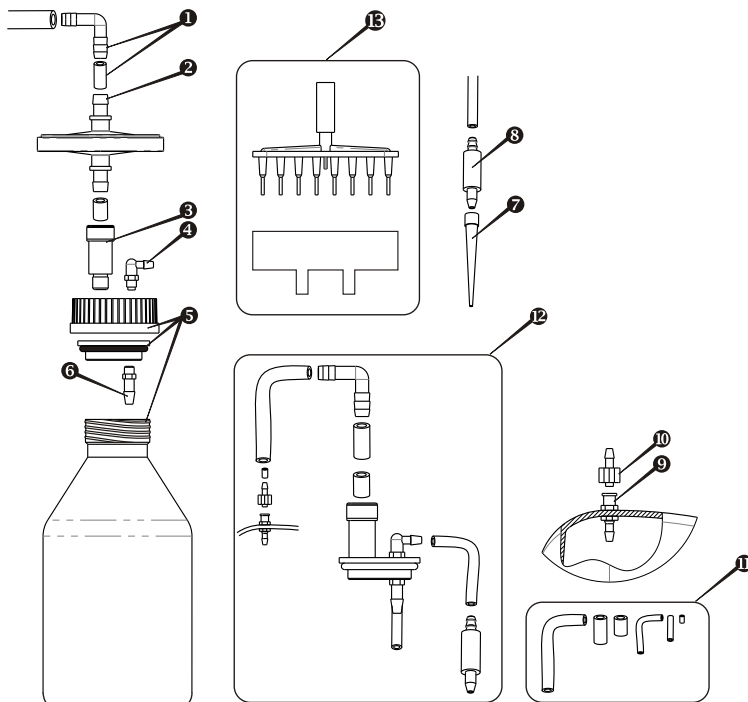

Fig.3 Replacement parts

Grant is committed to a continuous programme of improvement, specifications may be changed without notice.

6. Guarantee and Service

6.1. Guarantee

When used in laboratory conditions according to this instruction, this product is guaranteed for TWO YEARS against faulty materials or workmanship.

6.2. Service & Maintenance

It is recommended to change the tubes every six months (see p. Specifications table for item name of Tubing set).

It is recommended to change the microbiologic filter once in six months; in particular cases, e.g. at intensive laboratory research studies, once in three months (to order the filter, see p. Specifications table for item name).

Filter replacement (Fig.1/2). Disconnect the inlet and outlet tubes from the filter, remove the filter, insert a new filter into the socket and tighten it.



Attention! Observe location of the filter according to Fig.4. "IN" marking should be located on the side of the inlet tube (closer to the trap flask)!

For other maintenance and repairs return to our service department in the UK or in other countries, our distributor.

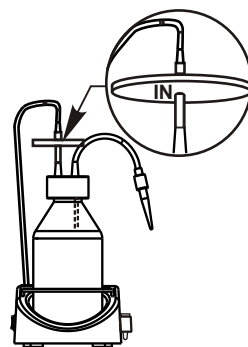

Fig.4 Filter mount

6.3. Cleaning & Disinfection

Standard ethanol (75%) or other cleaning agents recommended for cleaning of laboratory equipment can be used for casing cleaning and disinfection of the unit.

It is recommended to perform internal washing of tubes, adapters and tips with distilled water (volume 0.5 l or more).

Declaration of Conformity

Manufacturer:

BIOSAN LTD.
Ratsupites 7, build.2, Riga, LV-1067, Latvia

Equipment name/type number:

FTA-1

Description of Equipment:

Aspirator with trap flask

Directives:

EMC Directive 2004/108/EC
Low Voltage Directive 2006/95/EC

Applied Standards

Harmonized Standards:

EN 61326-1:

Electrical equipment for measurement,
Control and laboratory use -
EMC requirements
General requirements

EN 61010-1:

Safety requirements for electrical equipment
for measurement, control
and laboratory use.
General requirements

We declare that this product conforms to the requirements of the above Directive(s)

Signature
Svetlana Bankovska
Managing director

Signature
Aleksandr Shevchik
Engineer of R&D

1. 10. 2012
Date

1. 10. 2012
Date

Grant bio

**Grant Instruments
(Cambridge) Ltd**

Shepreth
Cambridgeshire
SG8 6GB
UK

Tel: +44 (0) 1763 260811

Fax: +44 (0) 1763 262410

Email: scientificsales@grantinstruments.com

www.grantinstruments.com